



SWISS SOUND

NEWS AND VIEWS FROM SWITZERLAND

STUDER REVOX

Editorial

Hi-Fi with a system concept

Only a few years ago it was fashionable to assemble a hi-fi system from carefully selected components from different manufacturers. Aside from the individual connectors and cables, from ground and impedance problems which made the setup a real challenge to a principally male oriented world, the individual components were relatively easy to interconnect. All that was expected was a good sound quality. Remote controls were OK for television sets but to extend this convenience to the world of hi-fi was unthinkable: those who wanted top-quality music had to invest some kind of effort to achieve it.

This is now a thing of the past. The remote control came and conquered! But in such a way that the user had to cope with a huge variety of hand-held controls, and he invariably picked the wrong one. The TV manufacturers responded quickly so that at least the different video sources and the screen could be brought under one hat. Revox was one of the first manufacturers to tackle the problem in the audio field. Even the volume control, the most difficult problem, was solved elegantly with digital/analog converters (DAC) in order to prevent any deterioration of the audio quality.

As in other applications, the microprocessor paved the way to new levels of sophistication: programming and storage of a growing number of useful parameters that contributed to the operating convenience without overburdening the user. With the B203 controller, Revox once again pioneered a new concept. In addition to the timer functions this unit provided for the first time the one-button operation. The commands sequences were integrated, and the microprocessor analyzed the remote control commands and decoded them into individual steps which in turn were transmitted to the various units in the right order. Users interested in even more sophisticated remote control facilities were able to establish a dialog with

the personal computer via the built-in RS232 interface of the controller.

Parallel to this development, there were new developments in the video field: stereophonic sound, laser vision, surroundsound, and recently CD video. It now became necessary to establish a connection between the audio and the video equipment. Thus a new controller, the B200, was developed. This controller enables the user to connect not only all new sources to the Revox system but will also (in a few months) incorporate their remotable functions via the intelligent B210 desktop terminal. The commands to the Revox equipment are transmitted by means of infrared, not only in one direction but bidirectionally.

This development, in conjunction with the remotability opened new perspectives, a fact which already became apparent when the B203 concept was introduced in the USA. There was a growing demand to have the same top quality of such a system available also in other rooms of the home, preferably by means of a single cable and without soldering iron. The new Easyline concept, currently being introduced to the market, is Revox's response to this. Any number of rooms can be interconnected by a single, permanently or temporarily installed cable. The tone, volume, as well as the connection of a decentral source can be remote controlled individually in each room without sacrificing the control of the main system. A complete

range of specific cables, sockets, junctions, and subcenters is available with unlimited possibilities for the user.

Requirements such as bidirectional infrared remote control, one-button operation, remotability and connectability of different video sources, and last but not least the multiroom technique (and all this simple and user friendly) clearly demonstrate that our development engineers were faced with a formidable and complex task. An amplifier is no longer just an amplifier, a tuner must be able to achieve more than just receive, and a CD player has other functions besides playing. In addition to their basic functions of receiving, amplifying and playing, these top-quality units must support dialog procedures and be systematically monitored for compatibility. The three new product lines introduced in this edition of SWISS SOUND fully satisfy these criteria and thus offer the Revox customer the assurance of owning a system that can be expanded and leaves nothing to be desired.

M. Ray



New amplifier and tuner families Revox B250/B260



Family concept

After the Swiss Hi-Fi exhibition, FERA 1968, a complete, Revox Hi-Fi system comprising a tape recorder (A77), amplifier (A50) and tuner (A76) became available on the market, for the first time with a uniform design.



Read in this issue:

	Page
• Family concept	1
• A820 Multi and telecom c4	7
• Who is who	10
• Seoul 1988 flash-back	11
• Studer Revox in Canada	12
• New in the Studer group	12

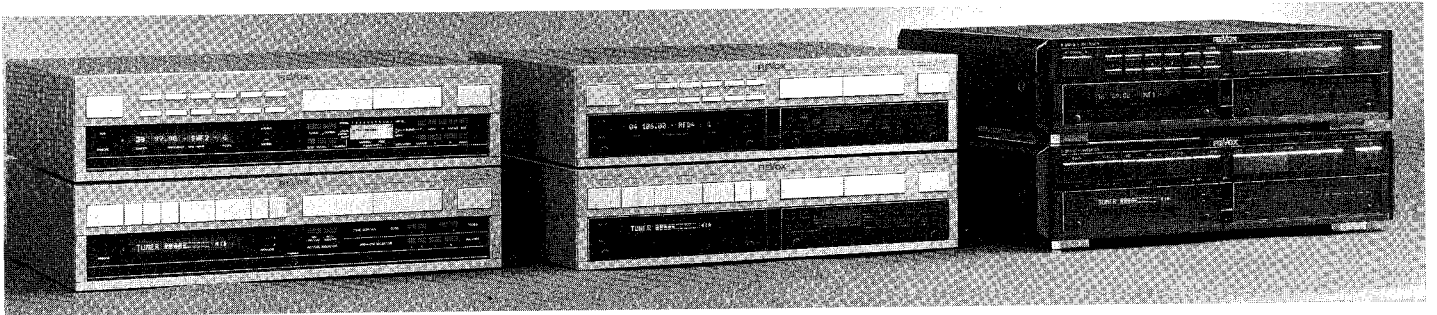

Premiere: Two complete product families in the Revox amplifier and tuner product line.

Exactly 20 years later we can now present an amplifier and a tuner family, each comprising three models. Strong affinities exist not only within the product families but also within the concepts of the tuner and the amplifier which show a surprising, interdisciplinary consistency. The two project managers, who obviously cooperated very closely, are now able to give us a glimpse into the concept and features of these two Revox families.

A family of three amplifiers

The new Revox compact amplifier generation now comprises for the first time a family of three interrelated models that cover a broad market segment. The objective, to build a powerful, highly versatile amplifier family in a compact Revox housing has been fully achieved

with the three models B250-S, B250 and B150. The proven design with vertically arranged PC boards, which is common to all three models, ensures excellent ventilation, which is essential in view of the high packing density.

The flagship of this series is the model **B250-S** with a black, polished front

Whenever a new equipment series is to be developed, it is important among other things to keep the costs at a reasonable level. This factor received particular attention in the development of the new amplifier/tuner generation.

Hardware and software relationship - an efficient concept

The cleverly designed synthetic front section which incorporates the push button guides, LCD holder, fluorescent display and microcomputer assembly, can be injection molded with the same tool for both equipment families by simply exchanging the keypad insert. Also the housing parts are shaped with the same bending tool. Except for a few differences in the mounted components, even the microcomputer assembly can be used in all 6 models.

This microcomputer assembly exemplifies how different hi-fi components such as tuner and amplifier can be implemented with the same hardware but different software. This difficult task is performed by two single-chip controllers: the first one, with largely identical software for all models, controls the keyboard, the IR decoding, the serial link as well as the Fluorescent Indicator Panel (FIP). The second microcomputer with its custom software is the actual device processor which takes care of the requirements either of the tuner or the amplifier.



Revox amplifier B250-S

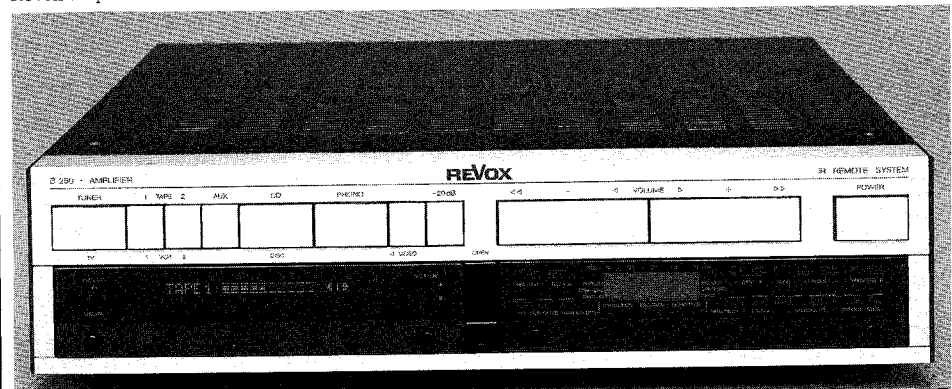

Revox amplifier B250

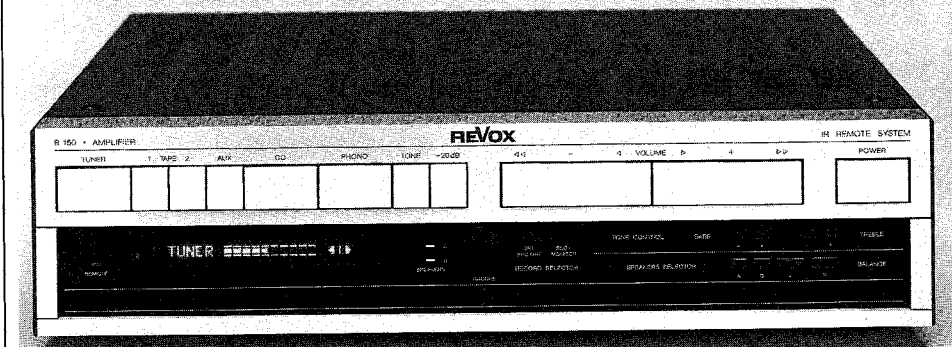

Revox amplifier B150

panel, push buttons with gold bevel, smoked-glass panels for covering the fluorescent display and the secondary operator controls, as well as genuine piano-lacquered black side panels.

The **B250** is technically identical but presents itself in a champagne-colored lock with synthetic side panels.

A true alternative is the **B150** amplifier. Its circuit technology is identical and the rated output power is somewhat lower, however the multitude of programming facilities and the controller port have been intentionally eliminated for the sake of operating simplicity.

Connection facilities as never before

The B250 with its many connection facilities satisfies all conceivable requirements:

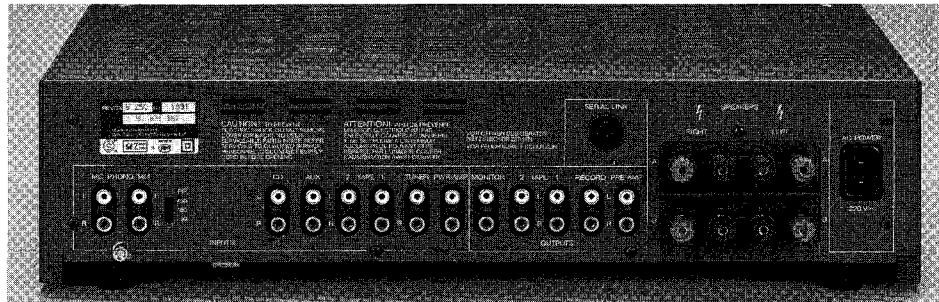

Rear panel of amplifier models. Never have more inputs and outputs been available!

- **6 Input sources:** CD, TUNER, TAPE 1, TAPE 2, AUX, PHONO which can be recorded independently on tape (record bus) or monitored (monitor bus). The phono input can be upgraded to PHONO MM/PHONO MC by means of an optional kit.

- **3 Tape outputs** (record bus)

In order to prevent feedback via the tape deck, the TAPE1 or TAPE2 output is automatically switched off when TAPE 2 or TAPE 1 is selected. The third output can be used in conjunction with the B209 subcenter for independent monitoring of a source in an adjacent room.

- **1 Monitor output** (monitor bus)

- **1 Switched preamplifier output** for connecting active boxes or for inserting an equalizer between the preamplifier and the power amplifier.

- **1 Power amplifier input**

- **Speaker output pairs** with gold-plated screw terminals for cables with a cross-section of up to 16 mm² or banana plugs.

- **1 SERIAL LINK socket** for the IR subcenter B209 or IR relay B206.

The B250 has an irresistible feature for HiFi-Video fans, namely the B200 controller, which is only approx. 40 mm high, and which can be screwed under the amplifier. In addition to its controller functions it expands the amplifier with the 4 video-audio sources TV, DISC, VCR 1 and VCR 2 plus corresponding video circuitry.

Programmable levels of the input sources

Apart from the standard operating functions such as VOLUME, BASS, TREBLE, source and speaker selection, which

can be activated by front-panel push buttons or on the hand-held IR transmitter B208, the B250 offers versatile programming facilities such as SENSITIVITY INPUT for all 10 (!) input sources, SENSITIVITY SPEAKERS, POWER ON VOLUME and MAX VOLUME for both speaker pairs and the preamplifier output. The 20-position FIP with 5 × 7 dot matrix displays the status of the main operator controls by means of graphic and text information. The small backlit LCD below the smoked-glass panel is used for the less important functions, and particularly as a programming aid.

A novelty is the semiautomatic programming of the input sensitivity (SENSITIVITY INPUT): In programming mode a peak meter measures the input level of the selected source. The value is compared with a reference stored in ROM of the microcomputer. The actual difference is continuously indicated by a small bar on the LC display and saved in nonvolatile memory as soon as the STORE key is released. Whenever the



The dot matrix display is not only the best available, it is also by far the most expensive. Examples: (top) standard indications at power-on are the source and the volume; (center) reproduction from CD and recording from tuner are clearly indicated; (bottom) a cursor indicates the setting of the tone control.

sources are changed over, the positive or negative difference is added to the current status of the volume. If all connected sources are calibrated with similar music, the volume difference is minimal when the sources are changed over. The advantage of this type of sensitivity programming is obvious: when a new source is to be connected, only this new source needs to be matched to the internal reference and consequently the other sources. Of course it is possible to restore the NOMINAL factory setting at any time.

Electronic switching and control elements

As is to be expected, not only the relays for the speakers and headphones but all other switching functions are implemented fully electronically, which means that they are not subject to wear. Low-noise opamps with low-pass filters serially connected to their inputs are responsible for the excellent suppression of RF noise and high crosstalk attenuation (over 100 dB at 10 kHz) between the inputs.

All amplification changes such as VOLUME, BALANCE, -20dB, and SENSITIVITY are performed individually for each channel by means of an electronic control element. The range is 100 dB with a resolution of 1 dB. A dual D/A converter 7528 sweeps the range from +22dB to -48dB. The missing -30dB are achieved by means of a passive attenuator. When the volume is lowered in 1 dB steps, corresponding software routines switch from -29dB on the DAC to the -30dB attenuator and 0dB on the DAC. On top of the fixed attenuation of -30dB, the variable attenuation range of 0 to -48dB is thus available, which means that the attenuator can sweep the full range of -78dB continuously. The process is reversed when the gain is increased.

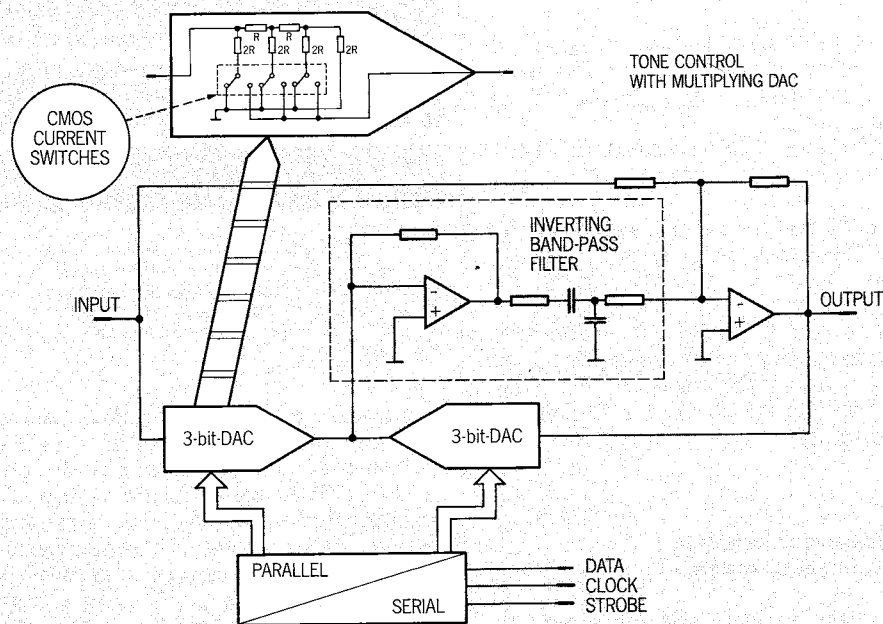

Block diagram of the high dynamic range equalizer circuit with 3-bit DAC.

Equalizer network with high overdriving immunity

To ensure that the high overdriving immunity can be transferred from the input to the preamplifier output, a corresponding equalizer network has been developed. Conventional designs are based on a noninverting band-pass in the feedback, and for varying the gain an electronically switched attenuator is used. This attenuator, usually implemented with low-cost CMOS switches of the Series 4000, can linearly process only signals up to 5 V eff. By contrast, CMOS switches as discrete, multiplying 3-bit D/A converters are used in the B250 amplifier to vary the gain. In this design, no voltage can occur on an open switch, so that only the subsequent opamp limits the output voltage to approx. 10 V eff. The bell-shaped characteristic for BASS and TREBLE is achieved with one inverting band-pass each in the feedback.

High-current output stage and efficient power supply unit

Two elements are of particular importance to the balanced sound characteristics of the new amplifiers: an extremely efficient power supply and a linear high-current output stage. The power transformer of the B250 consists of a cut toroidal core size 75B with two electrically isolated symmetrical windings that feed the two audio channels. In order to suppress mechanical vibrations at

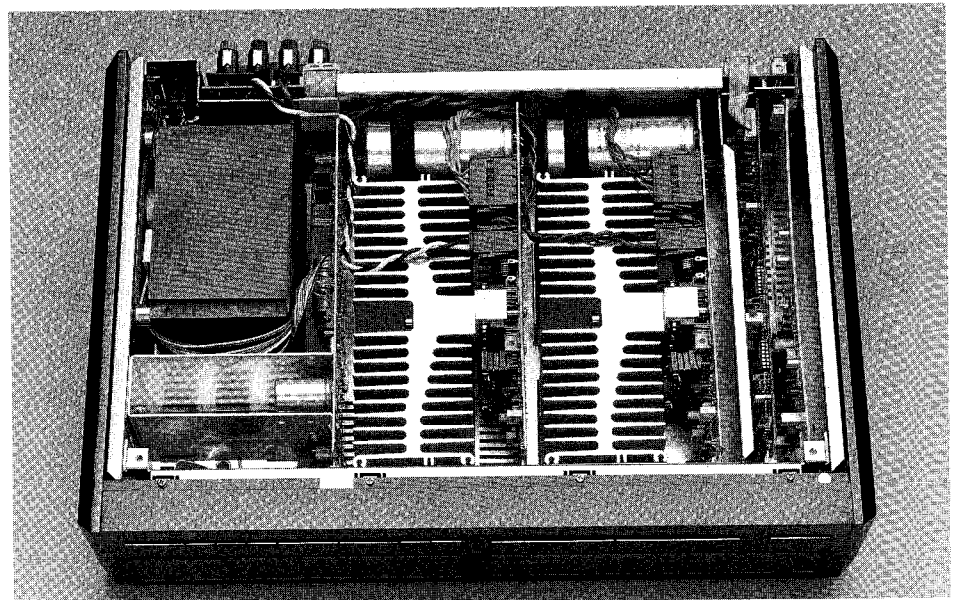

Thermal stability is ensured by large heat sinks.

the source, the power transformer has been encapsulated in a specially designed synthetic housing and screwed to the chassis via rubber shock absorbers. The extremely large electrolytic capacitors of the power supply with a rating of $2 \times 22000 \mu\text{F}$ per channel provide a large power margin in the extreme bass range.

The power stage itself features an absolutely balanced, fully complementary design. The low-level stage is operated with a higher voltage than the tail transistors, so that these can be driven with as little loss as possible when high

volumes are to be handled. Four parallel-connected high-speed transistors per half-wave ensure a high, linear current flow to the connected speakers. The heavy-duty heat sinks, already well-known from the B285 receiver, give the B250 the required thermal stability. $2 \times 200 \text{ W RMS}$ or $2 \times 300 \text{ W}$ music power into 4 ohms are the impressive performance data of this surprisingly compact amplifier. With this power it is even able to wake up power hungry low-impedance boxes (min. 2 ohm).

The concept of the neutral sounding high-current output stage has been retained for the B150. The output power is $2 \times 130 \text{ W RMS}$ or $2 \times 250 \text{ W}$ music power into 4 ohms. Three parallel-connected tail transistors per half-wave supply the current to the speakers. The electrolytic capacitors generously rated at $2 \times 15000 \mu\text{F}$ per channel provide more than adequate power margins in the extreme bass range.

Jürgen Hartwig

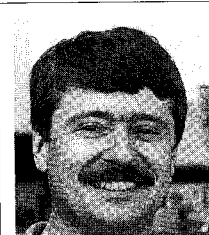

Jürgen Hartwig (37) studied electrical engineering at the Swiss Federal Institute of Technology (ETH) in Zurich. After graduation in 1974, he joined Willi Studer AG as a development engineer. Now group manager audio, special projects, and project manager for various Revox hifi amplifiers and the Studer power amplifier A68. Responsible for the development of the first Revox mixing console B279 and, lately, the amplifier group B150/B250.

A family of three tuners

The crowding of the FM band with more and more powerful transmitters belonging to private or public broadcasting stations, the large number of programs fed into broadband cable systems, and the radio data system (RDS) about to be introduced as well as the improvements in the quality of audio production and transmission equipment, have led to significantly more stringent requirements with respect to FM tuners.

It has always been the declared objective of our tuner development engineers to achieve a leading position with respect to tuner performance, audio output quality and ease of operation. The customer expects only top quality tuners from Revox. It therefore comes as no surprise that Revox tuners are frequently used as reference units by test magazines or used by broadcasting services for monitoring transmitted programs. This proven product philosophy has been retained also in the new tuner generation.

From the start our product strategy was designed to complement the **B260** tuner, introduced at the end of 1987, with additional models of different technical sophistication and prices in order to give the buyer a greater choice and to improve the market penetration.

The **B160** tuner has been tailored to the technical expectations of the broadband channel users; nonrelevant circuits and features have been eliminated. The tuner version optimized to this application has a favorable price/performance ratio but still belongs to the top quality category.

A completely new design is offered by the **B260-S** tuner. Its black-gold front and the valuable piano varnish side panels give it an unobtrusively elegant look. With its highly sophisticated features, its exceptional tuner performance, outstanding audio output quality and ease of operation, it is destined to be the Revox unit for the demanding tuner freak.

Operating ease for complex facilities

Within the scope of this brief report we can only mention the most important operating features, otherwise we would

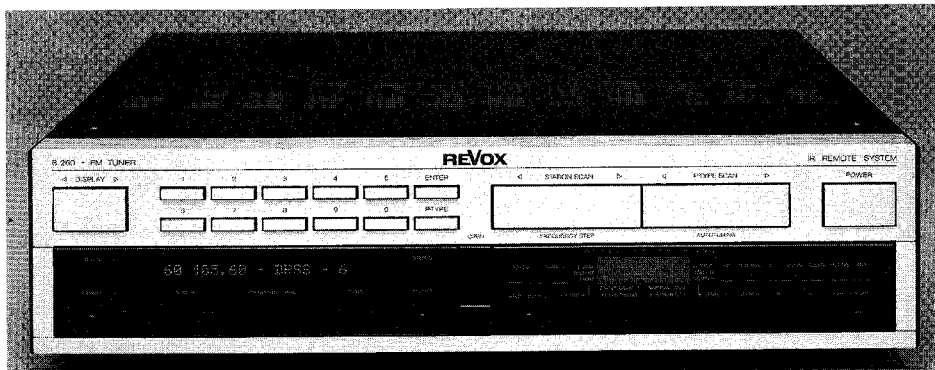

Revox tuner B260

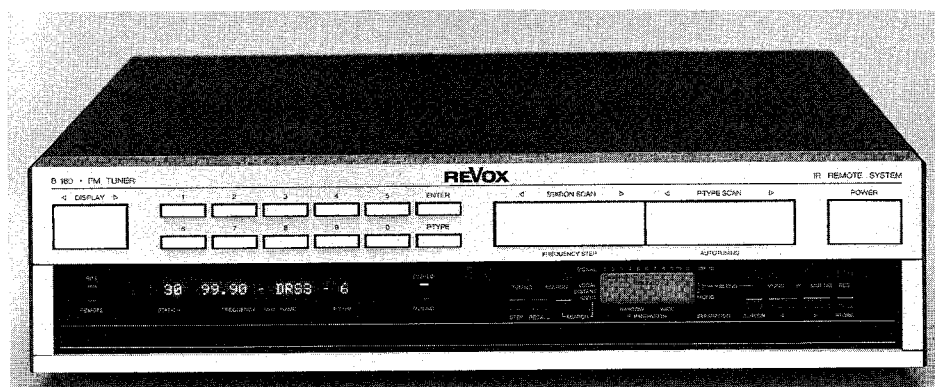

Revox tuner B160

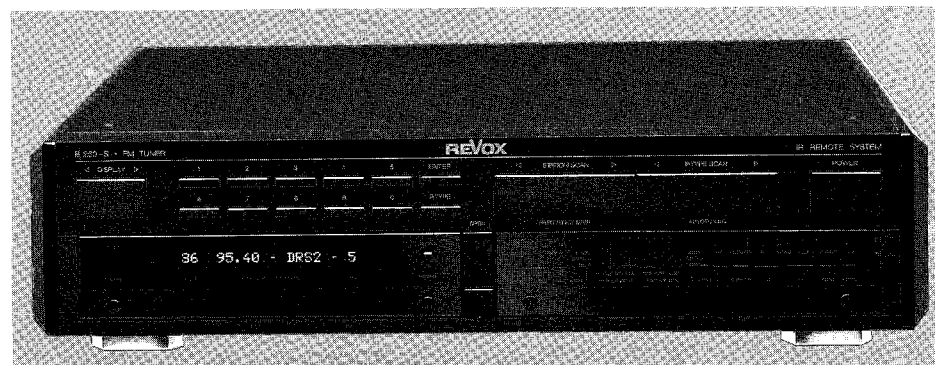

Revox tuner B260-S

need thirty pages like in the operating manual.

The tuner essentially features two operating modes. The first mode is intended for normal operation with a completely programmed tuner. Only the controls accessible in the top section of the front panel are operated. The procedure is so simple that anyone can find a station by means of the "Station Scan" rocker switch. Direct access to the stored stations is possible by entering the station number on the keypad. The program type assigned by the user to each station number can now be used for selecting the matching stations from among the up to 60 stored ones with "Type input" or "Type scan".

Comprehensive programming up to the volume level

The second operating mode is used for programming. All required controls are located behind the smoked-glass panel. The "Tuning" key switches the controls in the top section of the front panel to search, frequency step, and numeric frequency input. The stations can then be selected and stored in one of the 60 station memories. The frequency step resolution is 10 kHz. A 4-character station abbreviation, the aforementioned program type, as well as the complete set of tuning parameters (RF mode, antenna A/B, IF mode, Mono, Blend I/II, Muting, and RDS) can be stored. The tuner can be optimally adapted to the

existing reception conditions by means of the "Wide/Narrow" IF bandwidth selector and the "Single/Double" RF pre-selection. As we know FM stations transmit with different levels. Particularly the local radio stations tend to apply more "power" than the public broadcasting services in order to come in as loud as possible. With the programmable volume control it is now possible to individually adjust the volume of the toned-down classical stations to the volume of the pop stations and to store the corresponding adjustment on the station key.

Sophisticated displays for total information

The station numbers, the tuning frequency, the station abbreviation or the broadcast RDS name as well as the program type are shown on the large, brightness-controlled fluorescence dot matrix display. This sophisticated display can easily be read even from a great distance. The small LC display located below the smoked-glass cover is used for assessing the reception quality. The signal strength within a range of over 100 dB, the quartz-accurate center tuning information as well as the various tuning parameters are displayed.



The excellent dot matrix display serves as a complete information center on the tuner: displayed are the station number, frequency, RDS identification and program type.

A glimpse at advanced tuner technology with two complete input stages

For reasons of space we can only give a brief introduction to the most important of the new technical developments.

Today, a tuner must achieve not only a high input sensitivity but also an outstanding large-signal behavior. What use would a highly sensitive input section be if the low-noise signals of distant transmitters were masked with the noise of strong local stations. In a low-noise receiver with large-signal immunity, the antenna signal must be connected with minimal loss via a selective antenna circuit to the RC amplifier stage. Unfortunately, the requirements of low loss and high selectivity in the antenna circuit are

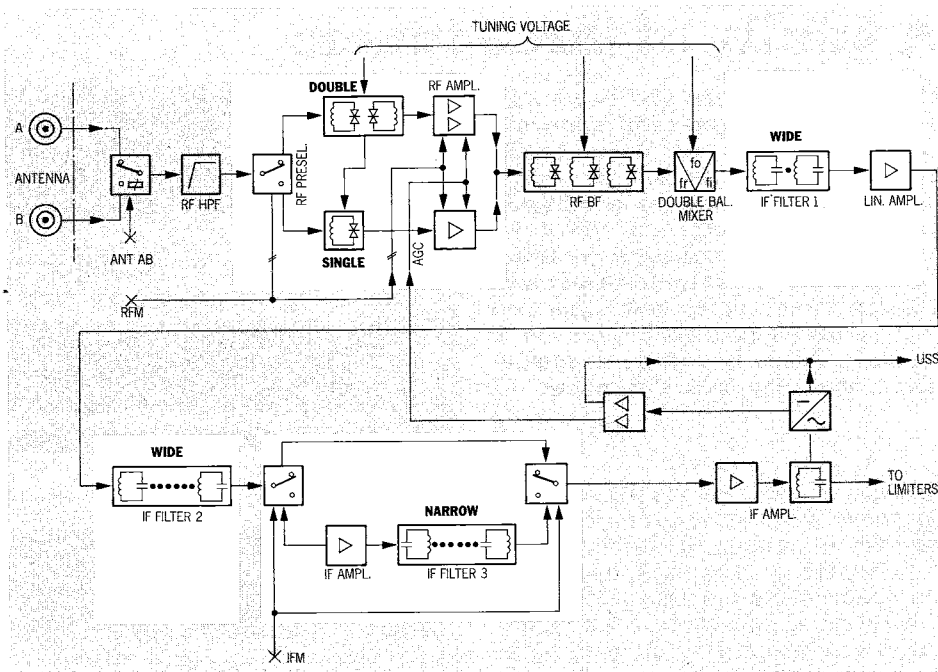

The block diagram illustrates the high-quality design with two complete input RF stages and two IF filter sections.

contradictory which means that no ideal solution is possible in every case. Being aware of how important an optimal RF input circuit is, we searched and found a solution to this problem. In order to cope with these two extreme reception parameters "low noise" and "large-signal immunity", a separate, high-dynamic RF input stage is connected into the signal path of the new Revox tuners by means of the appropriately labelled "Single/Double" selector.

The parallel connection of MOS field-effect transistor in the double path requires a smaller transformation ratio between the antenna and the transistor input for the same low-noise reception, which again improves the large-signal behavior.

Elaborate design for efficient selection

Efficient selection relative to interfering stations on adjacent channels takes place in the band-pass filters of the IF section. Due to the high dynamic range of the RF input section it is reasonable to correspondingly increase the IF selection, because the strong noise signals filtered out in the IF section can also be processed by the RF input section without adversely affecting the useful signal. This selection increase is in direct opposition to the requirement for small nonlinear distortion of the useful audio signal at high modulation frequencies.

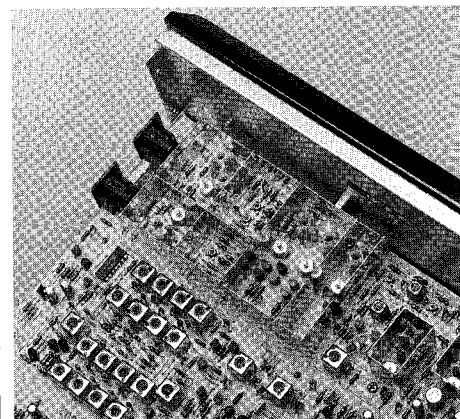

RF and IF circuits of the new Revox tuner: This electronic precision pays off in exceptional tuner performance.

Those who know that the distortion in the audio signal increases about by the power of four relative to the IF bandwidth reduction, will appreciate that individual adaptation of the IF selection to the corresponding reception conditions becomes necessary. Maximum selectivity with minimal distortions cannot be brought under the same hat; this problem can only be mastered with switch-selectable "Wide/Narrow" IF filters (bandwidths). Commercially available ceramic filters as IF selection aids are not suitable for our high-quality tuners. Due to the significant change in the group delay, the frequently observed imbalance of the attenuation pattern, and the manufacturing tolerance in the center frequency which is considerable despite stringent inspection, these fil-

ters do not satisfy the required quality criteria. Only LC toroidal band-pass filter systems with minimal modulation distortion fulfil our requirements. Accurate alignment on computer-monitored measuring stations is the key to the excellent consistency of the data in series production.

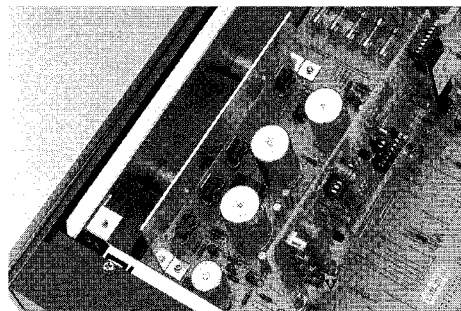

The new Revox tuners guarantee stability in the future: The RDS module supplies the data for the most convenient FM station search ever.

Future stability with Radio Data System (RDS)

In view of the gradual introduction of the radio data system (RDS) over the next few years in most European countries, it makes sense to exploit certain data offered in the RDS channel also in stationary FM receivers. The automatic indication of the station name with up to 8 characters as well as the selective search for stations with matching program ID are particularly useful features for programming a tuner. Through the installation of a small RDS module, all new Revox receivers are able to use this service. In this RDS module the 57 kHz RDS channel is filtered out of the MPX signal and demodulated to the digital 1187.5 bit/s information stream. A specially designed RDS microprocessor synchronizes itself to this serial data stream, disassembles it into the individual data blocks, and, after corresponding error correction, inputs it to the equipment control for further processing.

Ernst Mathys

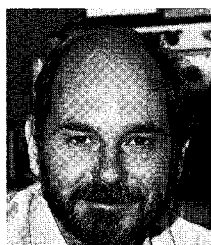

Ernst Mathys (51) studied telecommunications at the Engineering School of Zurich (ATZ), and joined the WILLI STUDER company back in 1959. After his graduation (1965) in electrical engineering, responsible for development in the audio and radio frequency field; project manager for REVOX tuners/receivers, and group manager for REVOX electronic equipment.

Radio Data System in brief:

The radio data system (RDS) is designed for transmitting digital auxiliary information over the FM broadcasting system. The radio data are transmitted in the form of a continuous binary data stream at 1187.5 bits/s. The data is organized in various 104-bit groups that consist of four 26-bit blocks each. These blocks contain the 16-bit information word and a 10-bit control word. The control word is used for block and group synchronization as well as detection and correction of certain transmission errors. This data stream is differentially and biphase coded and subsequently band-limited to 2.4 kHz. To achieve compatibility with the existing ARI traffic information system, the RDS signal is shifted with double side band amplitude modulation

to the 57 kHz frequency range. The phase angle of the suppressed RDS carrier to the ARI carrier is 90°.

During the introductory phase in Germany and Switzerland, the following information will be transmitted:

- PI program identification
- PS program service name
- TP Traffic program
- TA Traffic announcement
- AF Alternate frequencies

It is unlikely that in the near future more program-related data will be transmitted than those which have already been defined in the system.

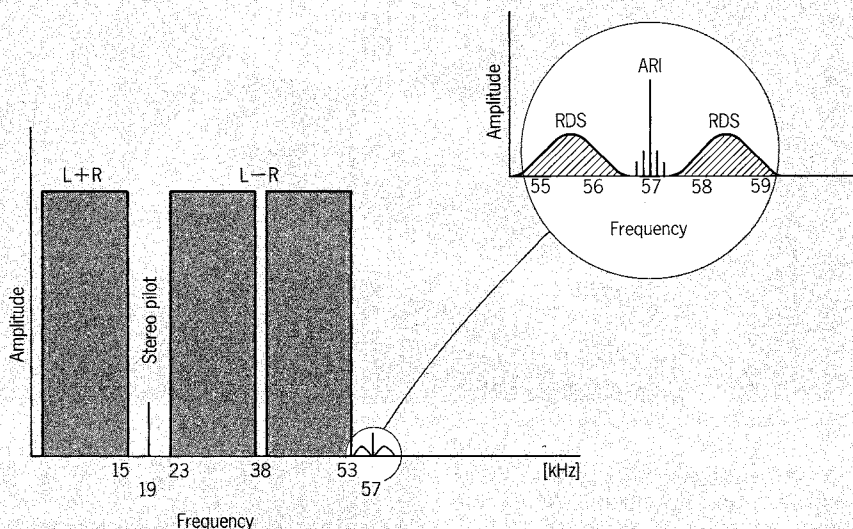

The diagram illustrates the RF spectrum of an FM station and the location of the ARI and RDS frequency bands.

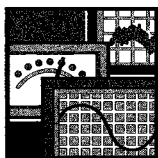

telcom c4 Compaander System
and the Studer A820

An Analogue Alternative to Digital Recordings

In order to achieve today the quality of sound recording in analogue recorders which only future 18- or 20-bit recording systems will be able to offer, several members of EBU (European Broadcasting Union) with leading reputations in the technical field have widely introduced and standardized telcom c4 companders. Thus, telcom c4 make it possible for these and more than a thousand other current users throughout the world to bridge the "technological gap" until a better digital recording method is available.

The telcom c4 compander system can be used wherever quality sound transmissions or recordings are to be made within a limited dynamic range. This high-quality noise reduction system is particularly important when used with multitrack recorders. telcom c4 reduces noise on the tracks to very low values. The dynamic range of recordings using the system is only limited at one end of the scale by the background noise of the studio, the microphone preamplifier and at the other by the acoustic pain threshold. telcom c4

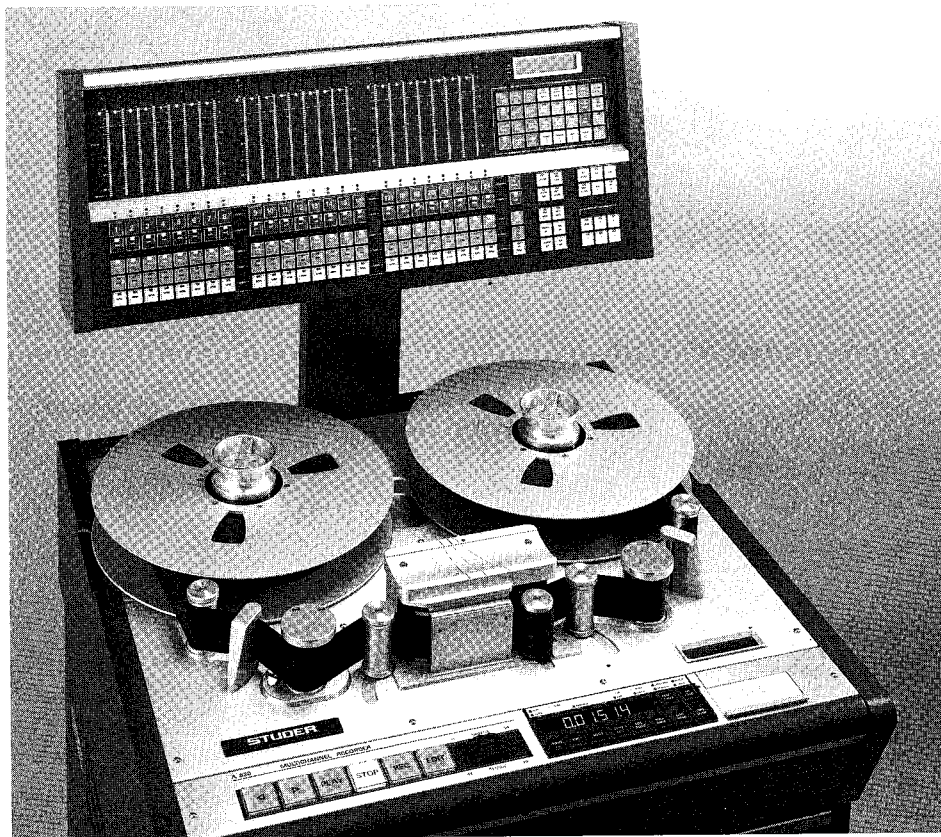

Fig. 1: The Studer A820 multichannel recorder with integrated noise reduction system.

enables recordings encompassing the full audible sound spectrum. When it is used in multitrack recording, telcom c4 offers enough dynamic range to give a stereo master better quality than a 16-bit CD.

The major advantage of the telcom c4 compander system is its large dynamic gain of approx. 30 dB and the improvement in the sound properties of the magnetic tape. Its functional characteristics reduce harmonic distortion, crosstalk, print-through and modulation noise from the tape. The system "cleans up" defects in the recording which are produced by the tape itself without adding spectral components to the original.

Because the physiological and auditory properties of the human ear were considered at every stage of designing the system, the telcom c4 can reproduce original sound with unsurpassed quality, both in terms of technically quantifiable and subjectively perceived quality. Together with the A820 multitrack recorder, the telcom c4 forms a mobile power-pack for high-quality recordings with the advantages of analogue recording and dubbing technology.

The following basic information on the system should provide a general understanding of how it functions.

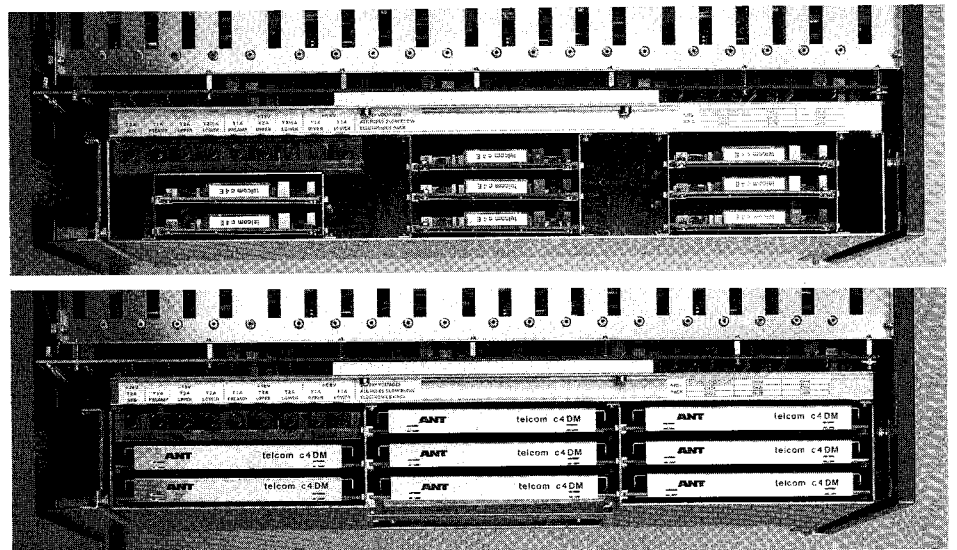

Fig. 2: The telcom c4E resp. c4DM units including interface are integrated in the drawer for eight audio channels.

Degree of compression

Assuming that studios normally have a background noise level of approximately 35 dBspl and that the pain threshold of the ear is around 125 dBspl, a dynamic range of approx. 90 dB is sufficient for sound recordings. In order to obtain this range with analogue tape recorders which have 60 dB dynamic range, it is necessary to compress 30 dB of the origi-

nal signal before recording. If such a compander system is to operate without level alignments and if, for example, any increase in the frequency response errors of the tape recorder due to expansion is to be kept to a minimum, then the only possible slope on the linear compander characteristic would be 1:1.5. This is why the telcom c4 system has such a characteristic (Figure 3). It treats the original sound much more gently throughout the operating range than other systems and enables a usable dynamic range of over 100 dB with analogue recorders.

Frequency distribution

When a broad frequency band is being processed in a compander system, the breathing and pumping of the tape noise become audible. The telcom c4 has an optimal technological method for preventing this. It does this by dividing the frequency spectrum into four frequency bands (Figure 4). These frequency bands differ in their width and are adapted to the sensitivity of the human ear according to Fletcher-Munson. They are more concentrated in the frequency

range where the human ear is at its most sensitive and thus avoid audible breathing and noise pumping.

Attack and recovery

The telcom c4 system contains in each frequency band an attack function which is adapted to relative level jumps in the original signal. The recovery time

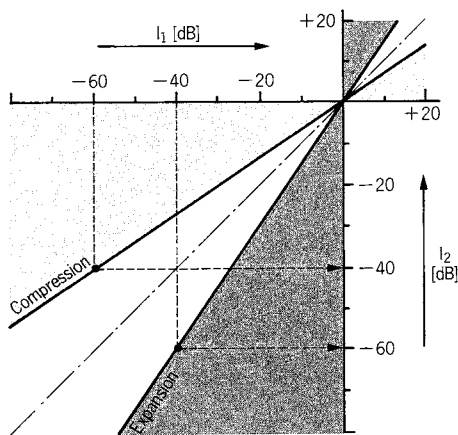

Fig. 3: Linear compander characteristic with a slope of 1:1.5.

constant is set so as to produce low distortion at low frequencies. The division of the frequency range into frequency bands and the optimized attack and recovery characteristics exploit the masking properties of the human ear most effectively. These have been described by Zwicker, among others. He has scientifically proven that in loud passages frequencies close to the original become masked and thus inaudible.

Even with critical sound signals the system does not pump.

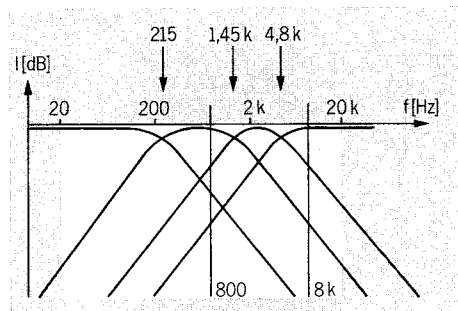

Fig. 4: The audible range is divided into four frequency bands.

The following is an explanation of the circuitry in extremely simplified form.

Compressor

In the compressor path, the frequency spectrum is divided into four frequency bands. Each frequency band contains its own compressor circuit. Since these compressors operate completely independently of each other, they ensure the best possible signal processing in each frequency band. If a drop out occurs in the tape recorder at high frequencies it has no effect on the lower frequency bands.

The compressor circuit operates in conjunction with two voltage controlled amplifiers (VCAs) and a smoothed peak threshold rectifier (Figure 5). The vol-

tage of the rectifier controls two amplifier stages parallel to each other. Due to the threshold value, a constant level is produced at the rectifier input which, apart from its time behaviour, is independent of the original input level but always a 100% compressed. Since the amplification of the second amplifier is twice as large as that of the first, the input signal after the first amplifier is compressed by 33%.

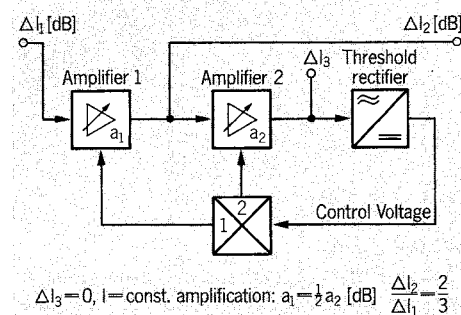

Fig. 5: The principle of logarithmic compression with VCAs.

The compression of the dynamic range constitutes $2/3$ (1:1.5). A logarithmic linear compander line is produced which is the system characteristic. A point is established on this line by means of the rectifier threshold which marks the nominal system level. It is reached when the static input level and the levels after the individual amplifier stages are the same. All signals above or below this nominal level are compressed towards it, i.e. higher levels are reduced and lower levels are raised.

The reduction of high levels increases the headroom of the tape recorder. By raising the low levels, particularly quiet passages are raised, which makes it easier to dub and cut compressed bands more precisely.

In order to uphold the principle of affecting the original signal as low as possible, the filters in the main signal path only have a 6dB/octave characteristic. The control circuit itself operates considerably more selectively at 18dB/octave.

A further important advantage of this circuit is that since complete compression occurs ahead of the rectifier, the control characteristics of equally large dynamic jumps are the same with different level ranges. A level jump of the input signal from e.g. -60dB to -50dB, has the same circuit behaviour as a level jump from -10dB to 0dB. Furthermore,

not only the static but also the dynamic time behaviour of the circuit is completely independent from alignment.

Reversing the characteristic

The complementary behaviour of the compressor and the expander is of particular importance. This is achieved by switching an expander circuit into the feedback of an inverting amplifier to form the compressor function. The same circuit in front of the amplifier is used for the expander function. This produces static and dynamic behaviour which corresponds exactly to the function of the compressor but in reverse. Thus it is an expander with the function of expanding the compressed signal back to its original value.

Improving analogue recordings with telcom c4

The telcom c4 system operates according to a simple mathematical function. It increases the dynamic range of a transmission line (tape recorder) by a factor of 1.5. But in the telcom c4 system, measuring with different weightings has no particular influence. The dynamic range of tape recorders can be increased by even more than 30dB, and this gain occurs significantly in every frequency range. The system has the major advantage of reducing the degree of harmonic distortion (the upper harmonics fall into the next highest frequency band and are reduced just like tape noise), crosstalk, pre- and post-echo and modulation noise. When used in conjunction with the telcom c4, an analogue tape recorder can surpass 16-bit digital recording in essential functions such as dynamic range and simple editing.

When using the system a very important advantage is that overmodulating with peaks does not result in clipping effects. High signals levels become compressed and therefore reduced. They may be only slightly limited by the tape recorder. This produces another useful dynamic range. The dynamic range which can be achieved with the telcom c4 is so large, that the quality of a tape recording in practice is no longer limited by the recorder. For this reason we recommend using the telcom c4 system with a tape recorder lined-up for reduced tape flux of e.g. 320 nWb/m at normal peaks. This results in additional improvements in distortion from tape without the danger of tape saturation at high frequencies. This means it is now possible to record with a linear compander system, without the need of adjustment

in the linear range of the tape while preserving the true original sound. The system dynamic range of the telcom c4 unit of 118 dB is large enough to ensure correct operation, even with different level settings.

telcom c4 in practical applications

The telcom c4 system offers an extraordinarily true sound. In practice it has proven to be a reliable, userfriendly system. Although it has an identification tone for identifying recordings and level adjustments, the tone is rarely used. There is no need for it. Due to the system's insensitivity to level differences, it does not need to be checked or adjusted when recording or playing back. Even recordings which have been compressed twice, produce good results afterwards. When tapes are changed, it is possible to compensate level differences with the console fader. For the purposes of identifying recordings, it is sufficient to mark recordings with stickers or simple descriptions.

The telcom c4 can be quickly, easily and reliably tested when necessary. This is done by feeding in tones with their band centre frequencies at the nominal system level and a reduction of e.g. 30dB at the input. Due to the 1:1.5 slope, this then produces 0dB and -20dB at the output of the compressor and 0dB and -45dB at the output of the expander. Since the system uses the same circuit for both compression and expansion mode, it is normally sufficient to test only in one operating mode.

The program: High-Tech with SMD c4E card

The c4E card forms the basis for all new equipment. The telcom c4 card has the same dimensions as a Eurocard (100x160 mm). The new SMD (surface mounted device) technology was used to enable the complicated telcom c4 system to be implemented on such a relatively small card. All the components required for a channel (switchable as a compander or an expander) are mounted on a single pcb. This means 70 operational amplifiers, 8 VCAs and, in all, over 350 SMD components. The new technology has not only permitted improvements in the system data and operational reliability but also reduced the power consumption of the circuitry.

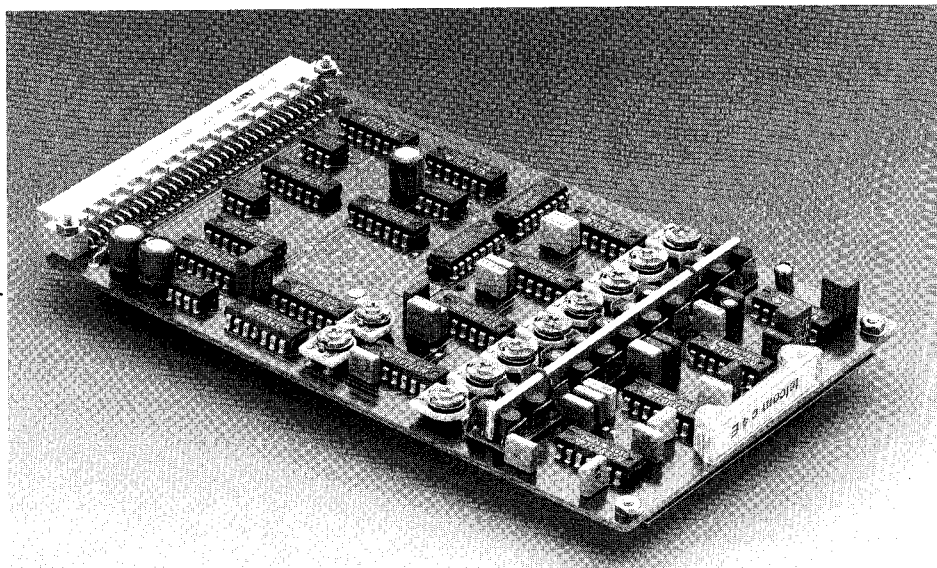

Fig. 6: telcom c4E compander card.

c4DM card

The telcom c4 compander card is designed for use in existing card slots of the older (Dolby) A system. It is mutually interchangeable with the cat22/cat280 system card.

telcom c4 as an integrated unit

Leading manufacturers are already offering the telcom c4 system as an integral part in their tape recorders and professional videotape systems. Studer decided to integrate the telcom c4 into its A820 recorders already during the early stages of development. The new A820 recorders are designed to accept both telcom c4 compander cards. Different interface cards enable either the telcom c4E or the c4DM to be an integral part of the recorder to suit customer requirements. This ensures that, even in its dynamic range, the A820 is a genuine analogue alternative to digital multitrack recorders.

Wolfgang Schneider

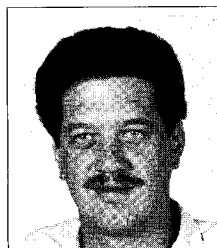

Wolfgang Schneider (37)

Diploma in electrical engineering at the Federal Institute of Technology, Lübeck in 1974. Since 1974 employed with ANT Nachrichtentechnik GmbH, Germany, former Telefunken Radio and Television GmbH. Worked on studio projects and sales in the sound systems department. Since 1979 sales and product engineer of telcom c4 Compander System.



The Studer Group

«Who is who»

This column has been reserved for introduction of personalities of our companies and representatives in Europe and Overseas.

Introducing:

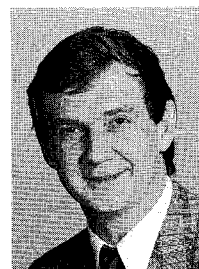

David Walstra

Product Manager Digital Audio of WILLI STUDER AG • born 1954 in Batavia (now Jakarta), Indonesia • grown up and school attendance in Holland • 1978 'Bachelor of Science' degree in Telecommunications • part-time studies of Digital Processing at the Polytechnic School of Engineering in Eindhoven, Holland • part-time studies of Economics at Amsterdam University • joined Studer in 1984 • just married.

Having received the B.Sc. degree of electronics in 1978, David Walstra worked with an engineering consultant company to gain practical experience in various fields. He joined the audio engineering department of the well-known Polygram of Holland 1979, to work on the analog mixing console sector. His PCM

background directed his interest towards early digital audio recording techniques for compact disc; Soundstream, 3M and Sony prototypes were tested and finally acquired for classical recording. Studer supplied 8 and 16 channel multitrack recorders specifically for testing purposes. Using the 8-channel version on various outside recording jobs and discussing its performance with the PCM laboratory of Studer, first connections with the Studer company were established.

At that time, David also worked periodically at the London-based Decca Recording Group as a liaison engineer between the brilliant Decca digital audio lab and the product development division of Polygram Holland.

In close connection with various famous personalities in the professional audio field, experience in mastering the 'art' of digital recording and product development came the natural way. In addition, his last year at Polygram was spent at the famous Wisseloord Studios assisting to make digital stereo and multichannel recorders fit into daily routines, video systems included. In 1984, he was asked to join Studer.

As assistant to the Managing Director of Studer International AG, Eugen Spörri, David Walstra was engaged in marketing and sales matters and supported Dr. R. Lagadec, then in charge of PCM development at Willi Studer AG, in external affairs; he finally joined Product Management Digital Audio, Professional Recording Systems, of the parent company in 1986.

The area of his responsibilities is widely spread. He shares all duties with his colleagues Bruno Hochstrasser and Andreas Koch, such as product and product line definition. This means constant communication with the engineers during the development phase of a product, testing functional prototypes, placing these in a professional environment for more severe evaluation, continuously back-feeding findings for further improvement of the machine. It also includes assisting the international sales organisation with product introductions in the various markets with the help of its experienced product engineers.

His job requires extensive travelling for introduction of new equipment at exhibitions and conventions, and includes familiarizing distributors and their sales staff and technical personnel with latest Studer technologies. An important task is sampling the requirements of the markets he visits, whereby Japan is a spe-

cially well-observed area of interest. David Walstra also surveys trends and developments on an international level with many useful sources he has available in the professional audio industry. As a member of EBU DATR/G1 group of specialists for digital audio recording, of the DIN working group on digital audio 2-channel standardization, he often attends AES technical working groups.

For healthy compensation, David favours motor cycle riding, tennis and squash, and skiing as pastime activities. He obviously enjoys life in general.

"For me, it is most challenging to work in the Studer group on an international level", David Walstra states. "In my profession, I am greatly fascinated by industrial development, by the internationalization of industries, and the balance (or imbalance) between the European, American and Japanese industrial powers, which in effect link industry and culture of the various nations to obvious advantage. We should welcome new developments, and make them work for us."

Renate Ziemann

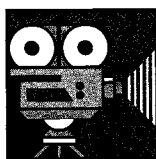

South Korea

Flash-back - Olympic Games Seoul 1988

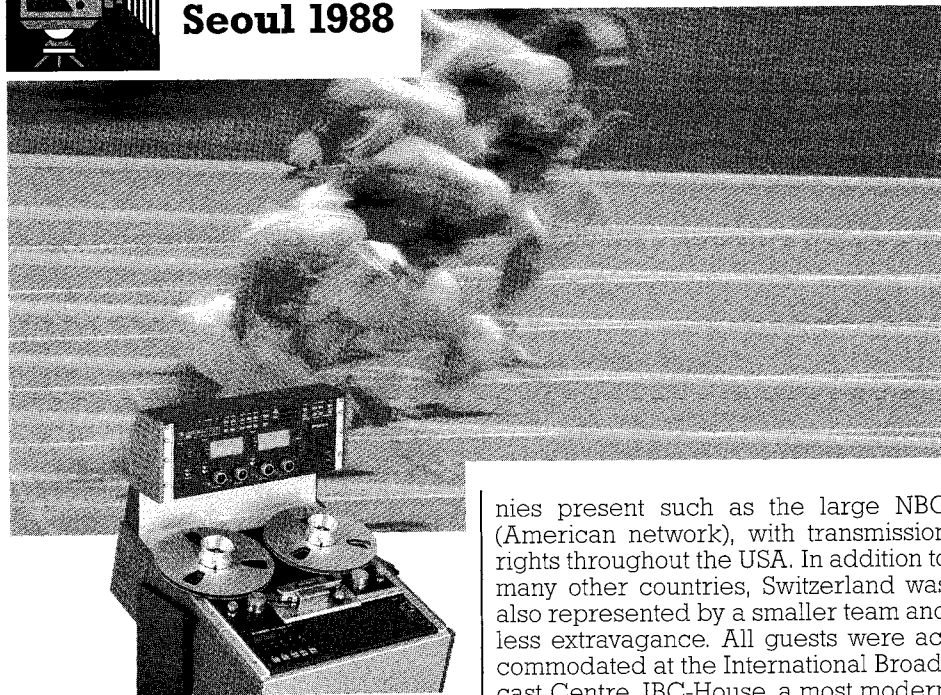

With the Asian Games successfully passed in October 1986, Korea has shown the world one of the most spectacular events with this year's Olympic Games in Seoul from September 17th to October 2nd. More than 160 countries with over 9000 athletes have participated. 60% of the olympic premises had already been prepared in 1986 for the games in September 1988.

The two largest networks, the Korean Broadcasting System (KBS) and Munwha Broadcasting Company (MBC) were involved in the great task of presenting the Olympic Games to a demanding public worldwide. There were international guest broadcasting compa-

nies present such as the large NBC (American network), with transmission rights throughout the USA. In addition to many other countries, Switzerland was also represented by a smaller team and less extravagance. All guests were accommodated at the International Broadcast Centre, IBC-House, a most modern concept, specially designed for the purpose by a renowned British development group. SORTO, umbrella organisation responsible for the realization of the Seoul games, has proudly announced that never before had more equipment been used for such occasion - after all, 20% more than in Los Angeles four years ago. The largest percentage of electronic equipment that has been used in Seoul is of Korean manufacture (45%).

STUDER REVOX has participated in this occurrence as well, with supplies of equipment such as tape recording machines of the new A807 series, the A810 time code version for synchronisation, mixing consoles 961/962/963 and their successful predecessors Studer 169/269

for excellent sound reproduction and telephone hybrid systems for on-the-spot reporting.

In the whirl-pool of big business, many Korean private companies in the radio, video and audio field have expanded or even renewed their studio outfits - the boom was programmed. For STUDER REVOX, business had taken a positive trend in Korea long before the games took place. Due to the long-standing presence in the market and the reliability of a complete product range, notable projects have been carried out by DEASAN INTERNATIONAL of Seoul, exclusive Studer Revox distributor. One customer alone has equipped his studio with 56 tape recording machines Studer A807, and 23 mixing consoles of the Studer 960-series, all accommodated in functional and attractive studio consoles.

Spectacular olympic events give manufacturers of broadcast equipment quite obviously the chance to prove the quality of their product range behind the scene in a more unspectacular contest.

Paul Meisel

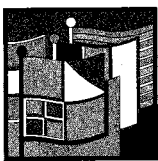

STUDER REVOX in Canada

Studer Revox Canada Ltd., Toronto, announces the opening of a new office in Vancouver, western region of Canada, for sales and service of the product range.

It coincides with the appointment of Mr. Robert McKibbin as Regional Sales Manager for Western Canada. A graduate of the University of Western Ontario, Mr. McKibbin has held sales and marketing positions with manufacturers of both professional and consumer audio equipment. For the past five years, he has represented Studer Revox and other products through his own company in Western Canada.



New in the Studer group...

KINOVOX Denmark



The KINOVOX team, engaged in marketing and sales, servicing and import matters.

As of July 1, 1988, Studer International AG has appointed **KINOVOX A/S** of Lyngbe as the new representative of Denmark. KINOVOX will act as the sole distributor for Studer professional audio products and handle sales and service matters in Denmark, Greenland and Faroe Islands.

Founded in 1943, KINOVOX has started as a one-man company, mostly renting large loudspeaker systems for indoors and outdoors activities, as well as

repairing loudspeaker and cinema sound equipment.

Today, 45 years after the foundation of the company, KINOVOX has developed to become one of Denmark's most reputable manufacturers and importers of professional sound equipment. With a staff of approx. 25, the company's aim is to offer best quality and service on all equipment, to the benefit of its customers.

Kuno Lischer

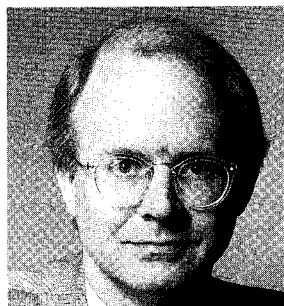

Robert McKibbin, Regional Sales Manager

We convey our best wishes for a happy start and prosperous business to our new regional sales manager.

Editor:

Marcel Siegenthaler

Contributors of this issue:

Jürgen Hartwig, Kuno Lischer, Ernst Mathys, Paul Meisel, Michel Ray, Wolfgang Schneider ANT, Renate Ziemann.

Please mail your letters to:

SWISS SOUND, STUDER INTERNATIONAL AG
Althardstr. 10, CH-8105 Regensdorf
Telephone + 411 840 29 60 · Telex 58 489 stui ch
Telefax + 411 840 47 37 (CCITT 3/2)

Artwork: Lorenz Schneider

Publisher: Willi Studer AG, Althardstr. 30,
CH-8105 Regensdorf

Reprint permitted with reference to SWISS SOUND (please send a copy to the editor).

telcom is a registered trademark of ANT Nachrichtentechnik GmbH

Dolby is a registered trademark of Dolby Laboratories Licensing Corporation.

Printed in Switzerland by WILLI STUDER AG
10.23.8200 (Ed. 1088)